A photograph of a chef in a white hat and a woman laughing together outdoors. The chef is on the right, wearing a white chef's hat and a blue and white striped shirt. The woman is on the left, with blonde hair, wearing a white tank top. They are both smiling and laughing, looking towards each other. The background is a blurred outdoor setting with green foliage.

Estas churrasqueiras são o resultado de anos de experiência e pesquisa em soluções que respondam com qualidade e ao gosto dos nossos clientes.

Os materiais empregues no seu fabrico são os mais adequados para obter os melhores níveis de qualidade e garantia ao preço mais interessante. Incluímos nas nossas propostas toda uma ampla gama de possibilidades para o seu jardim ou terraço.

Esperamos que as desfrute! Como estamos certos de que tudo pode ser melhorado, é com muito gosto que estamos disponíveis para escutar todas as suas sugestões.

# VISION ARTE

CHURRASQUEIRAS  
Módulos suspensos

# VISION ARTE

A ARTE DE GRELHAR TAMBEM EVOLUI



CORES  
DISPONÍVEIS



4247



4411



4410



1993

## CHURRASQUEIRAS Módulos suspensos TRIANA



## OPÇÕES DE CAMPANULAS KUBICA E POLKA



## OPÇÕES DE MOVEIS AMOVIVEIS MODELO VIKTORIA



## ACESSÓRIOS

## ALGUNS EXEMPLOS

## FORMAÇÃO COMERCIAL

# DISPOSIÇÃO DAS BANCADAS À ESQUERDA OU DIREITA



TRIANA 100

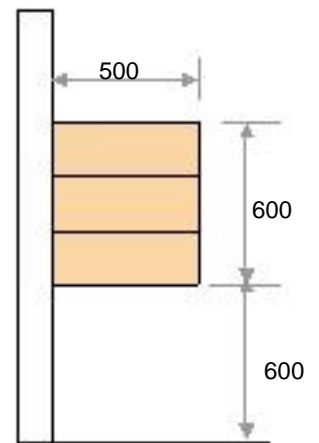
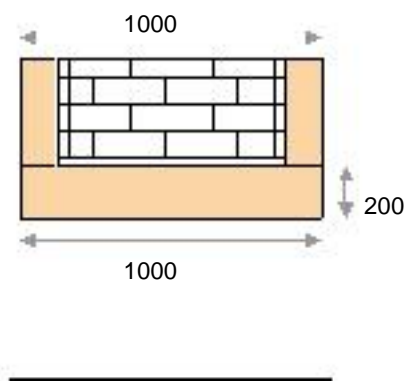

TRIANA 100.10

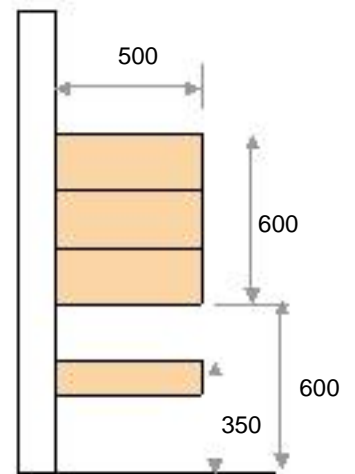
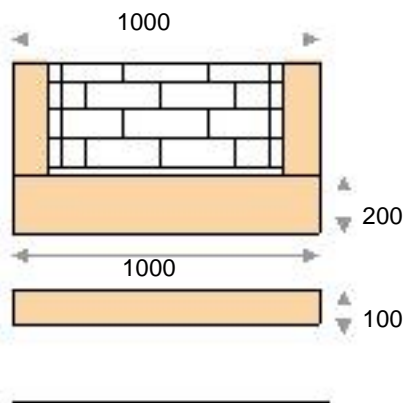

TRIANA 150

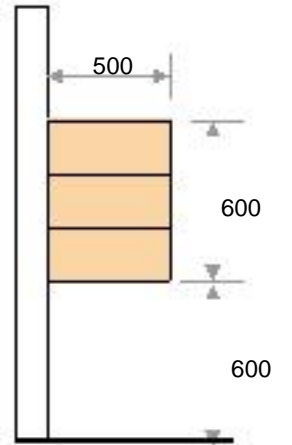
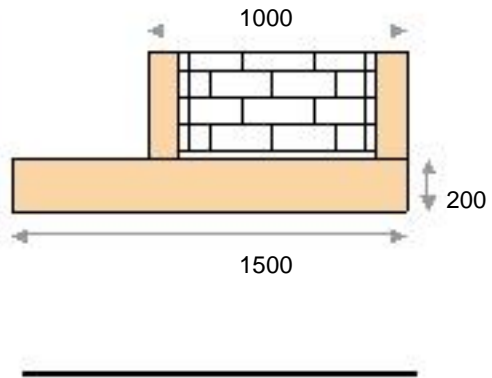

TRIANA 150.10

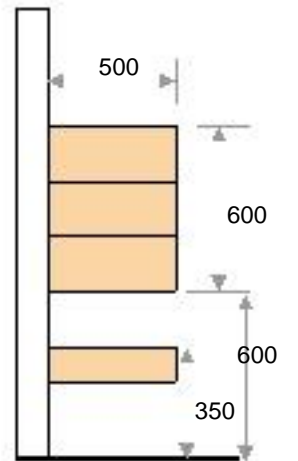
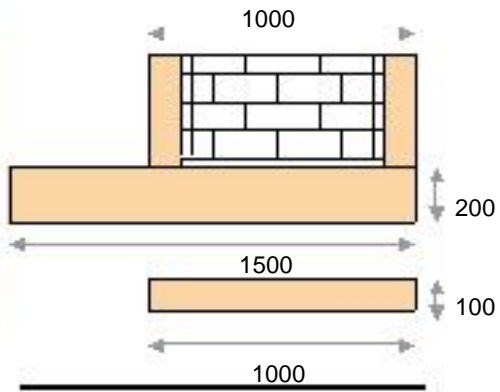

TRIANA 150.15

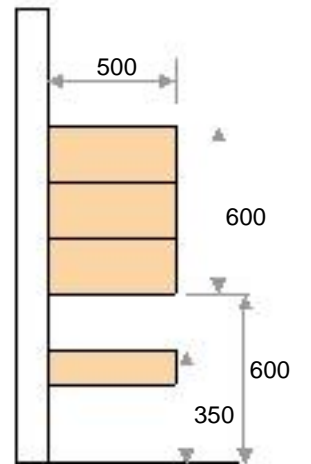
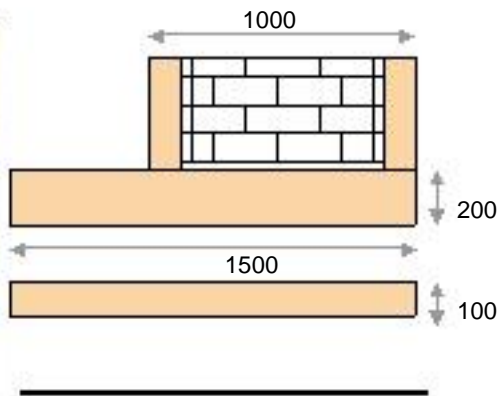

TRIANA 180

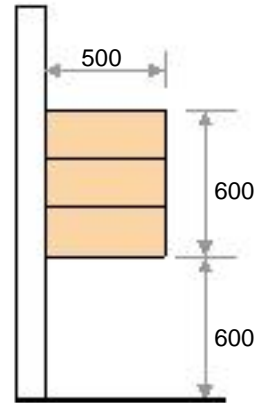
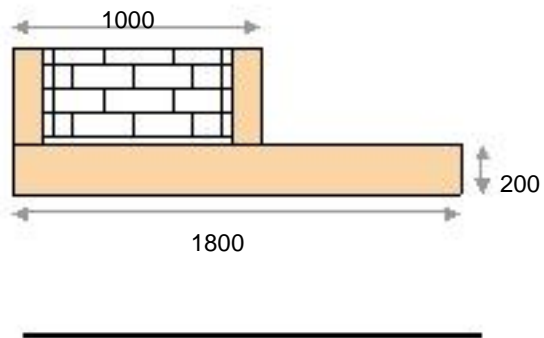

TRIANA 180.10

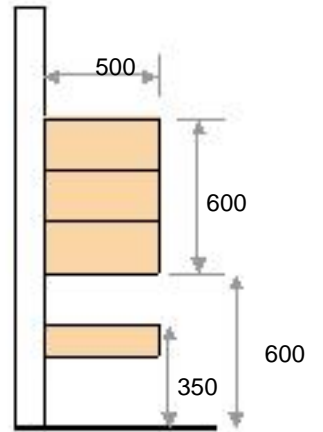
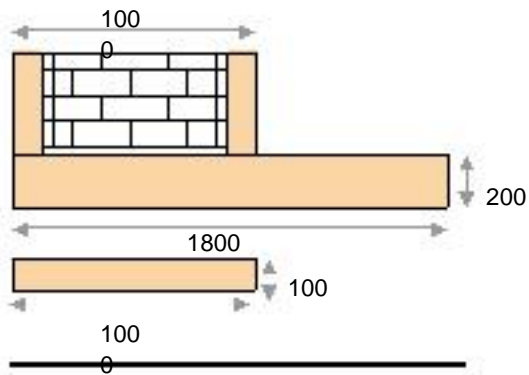
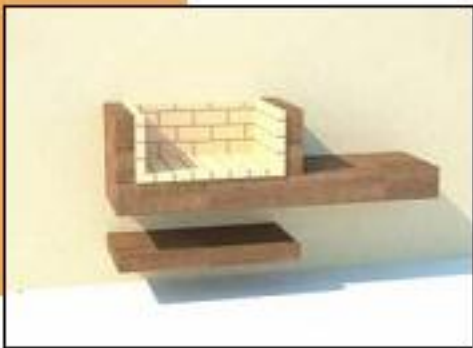

TRIANA 180.18

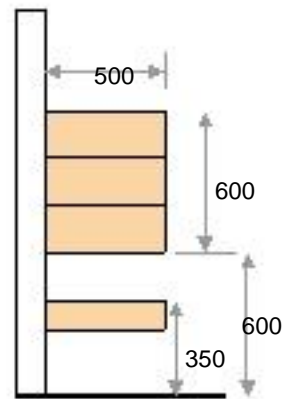
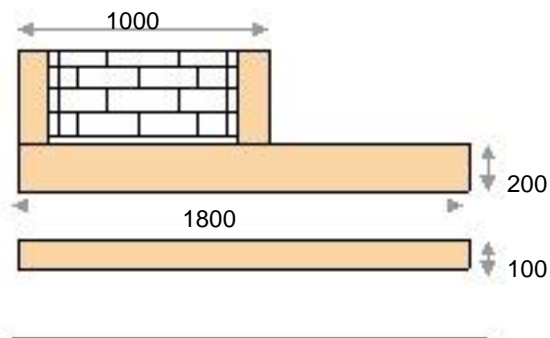

TRIANA 230

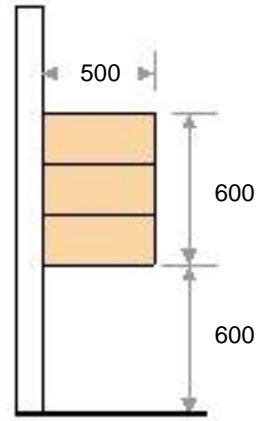
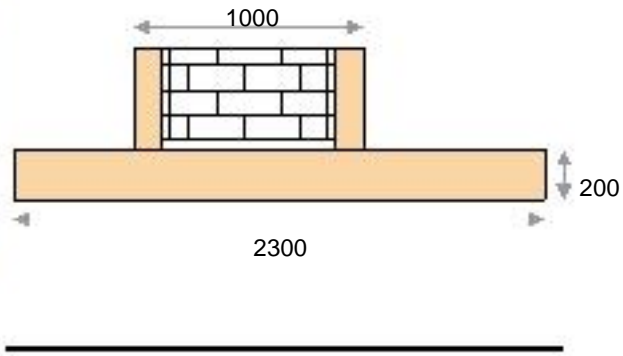

TRIANA 230.10

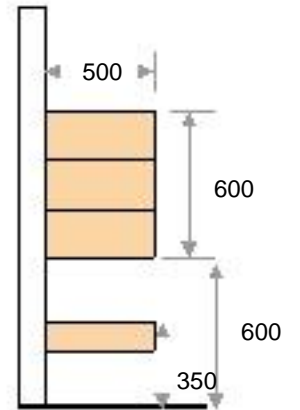
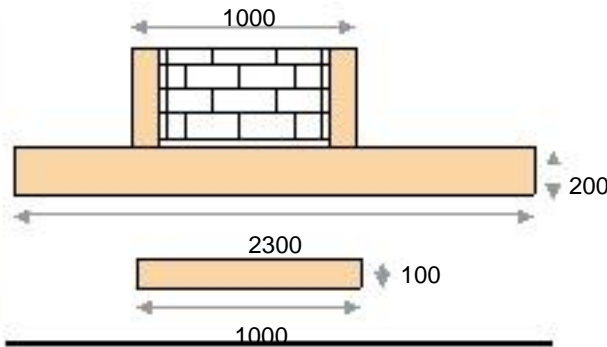

TRIANA 230.18

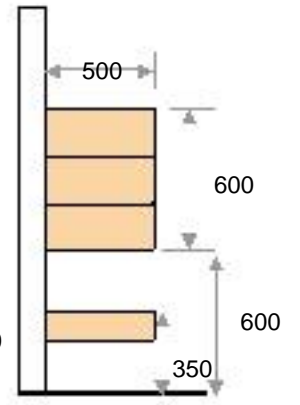
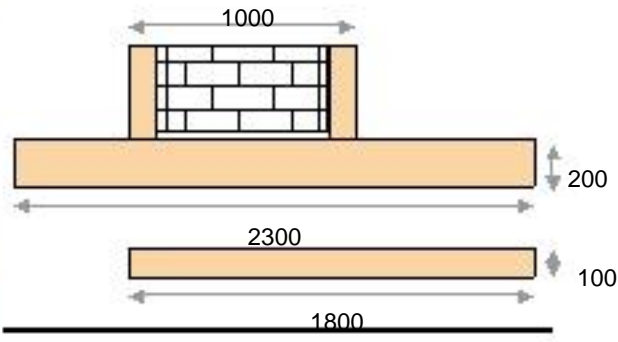

TRIANA 230.23

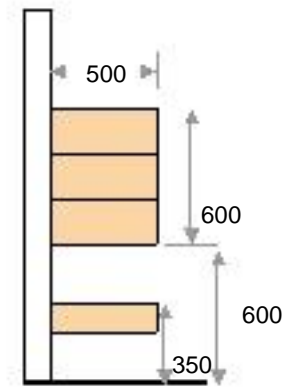
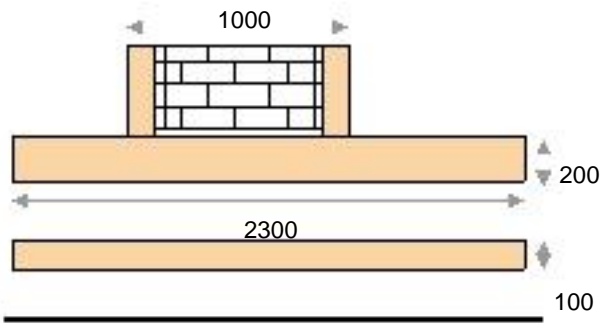

VIKTORIA 100

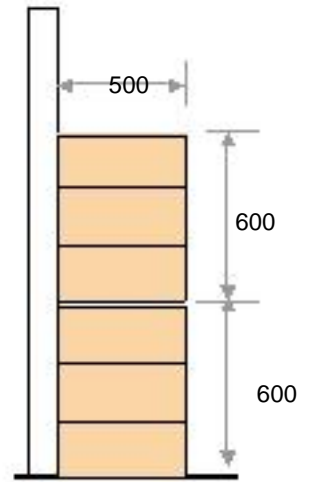
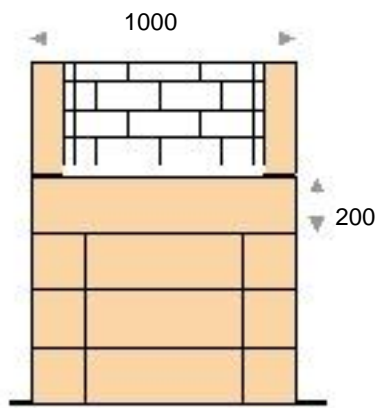

VIKTORIA 150

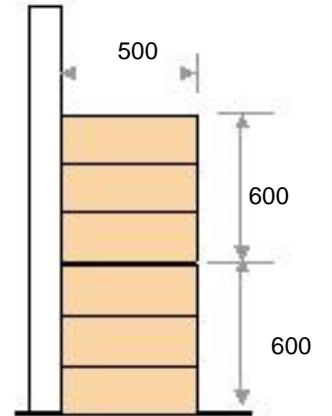
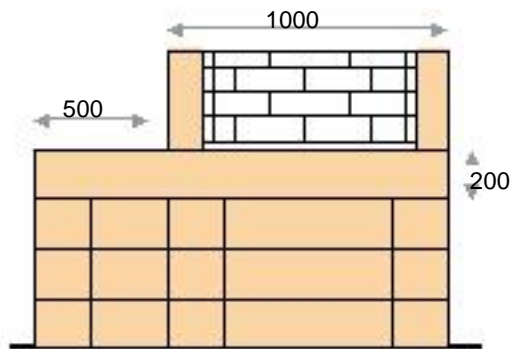

VIKTORIA 180

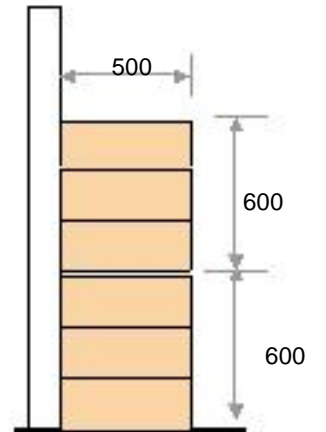
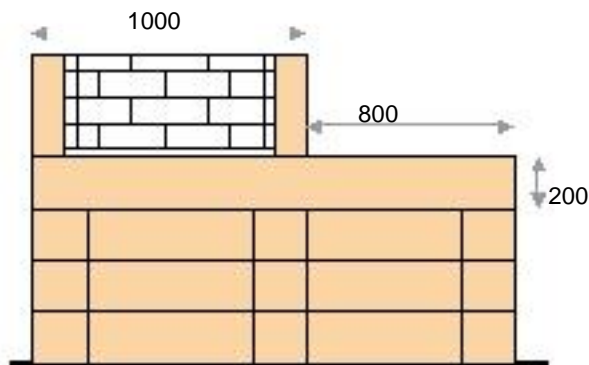

VIKTORIA 230

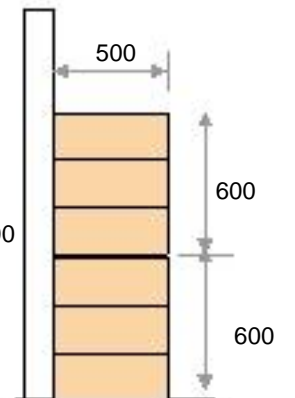
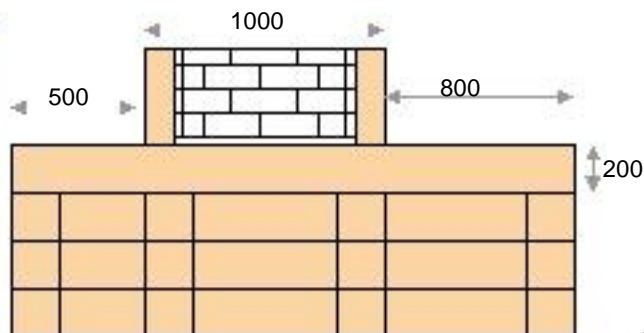



AGNES 150

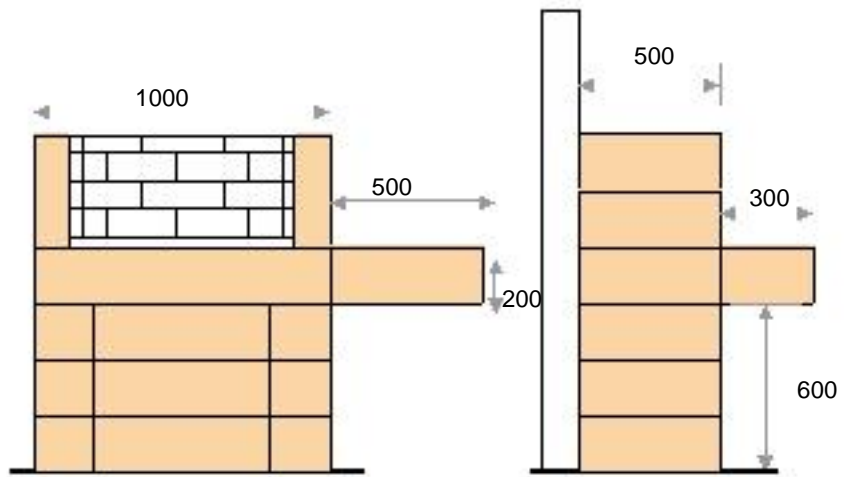

OCTAVIA 150

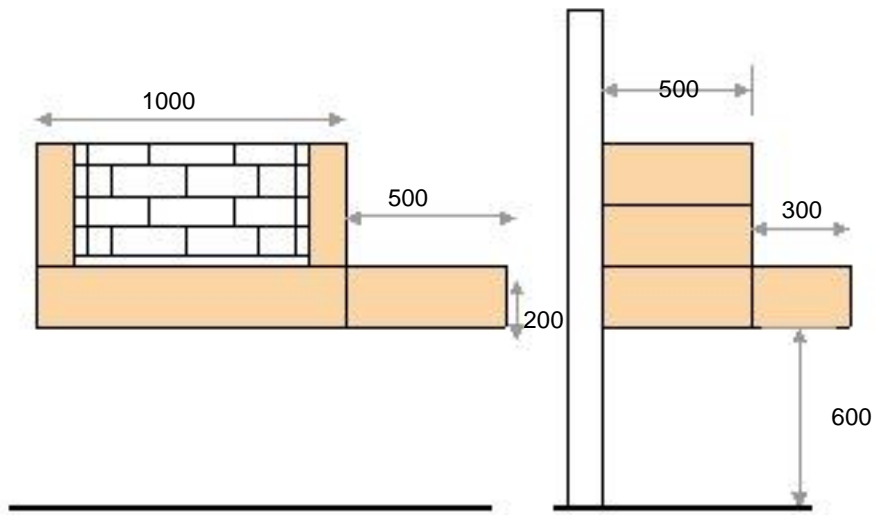

CANTO 200

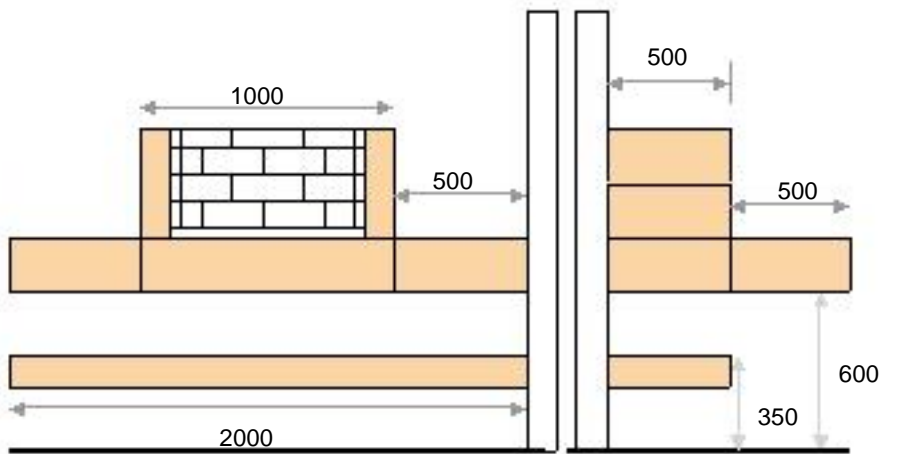

## OPÇÕES DE CAMPANULAS KUBICA E POLKA

### CAMPANULA KUBICA **NOVIDADE**

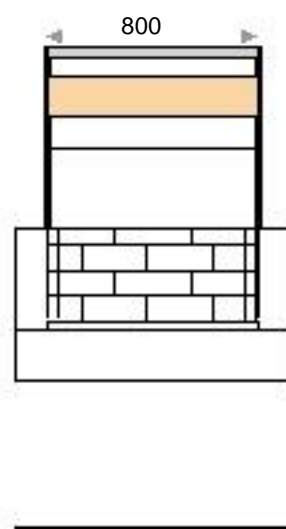
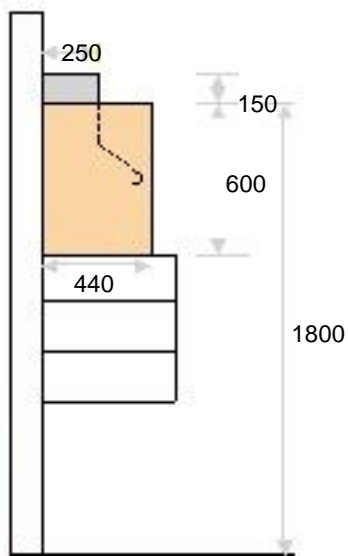

### **vantagens**

A sua fixação é feita na churrasqueira  
( não necessita de uma parede mais alta)

Todas as gorduras escorem para a zona  
de queima



## CAMPANULA POLKA

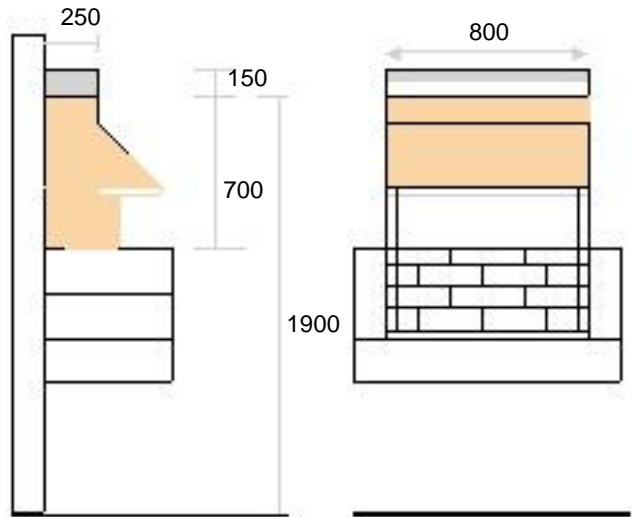

## PROTECÇÃO PAREDE INOX

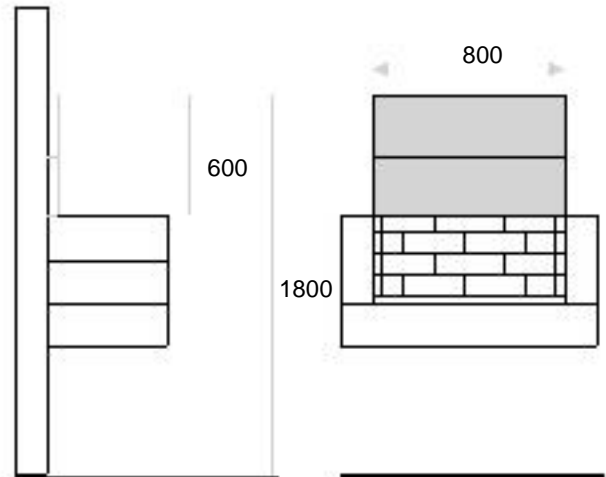

# OPÇÕES DE CONDUTAS DE FUMOS PARA CAMPANULAS KUBICA E POLKA

DUAS OPÇÕES PARA CAMPANULA KUBICA E POLKA  
QUADRADO 250 X250 INOX ESMORILADO  
REDONDO 250 DIAMETRO INOX ESMORILADO

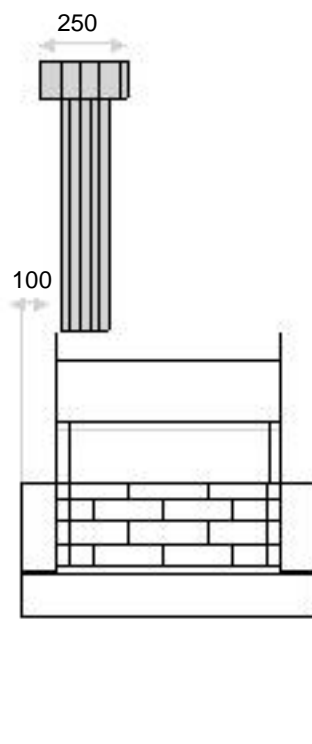
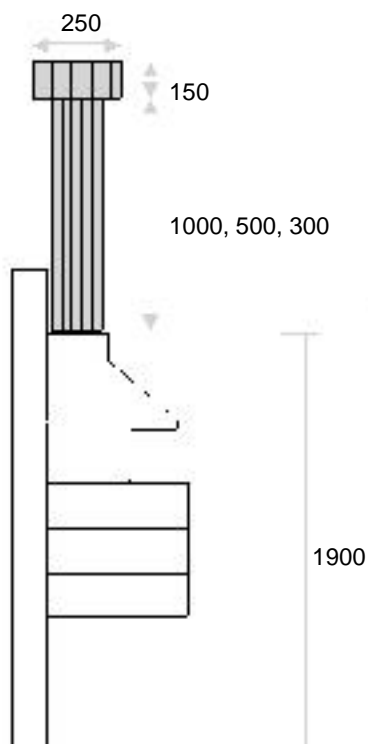
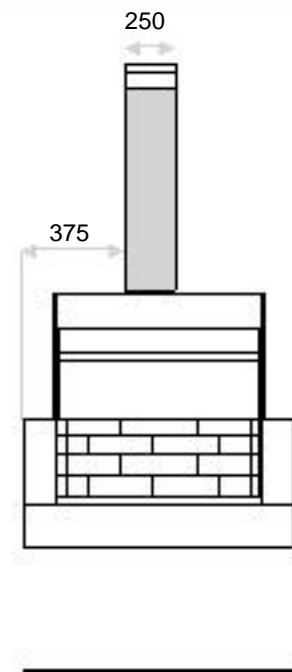
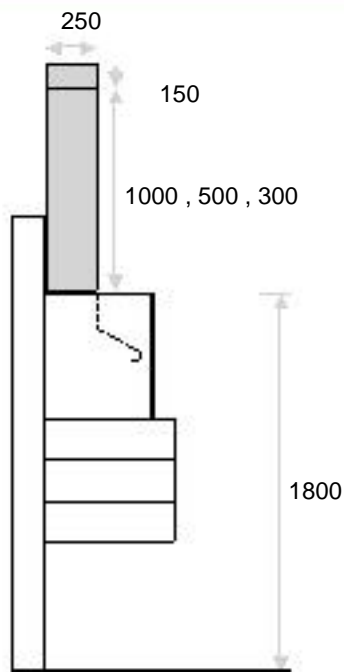

# Conceito moveis de base de chão

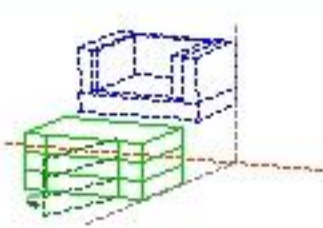

Modulo 100

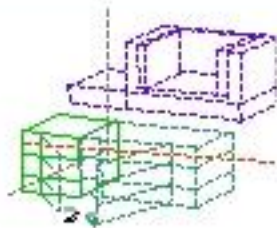

Modulo 150



Dinâmico  
Constante mutação

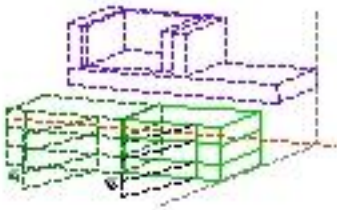

Modulo 180

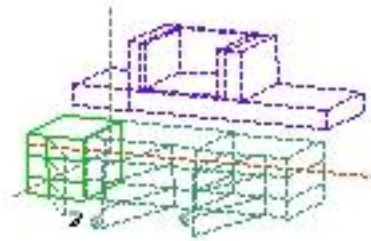

Modulo 230



80

50

100

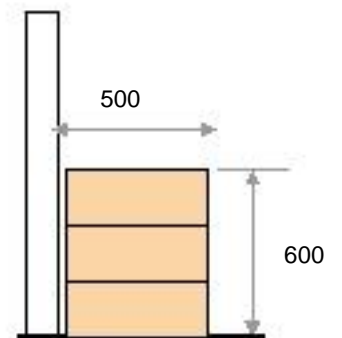
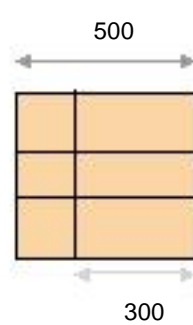
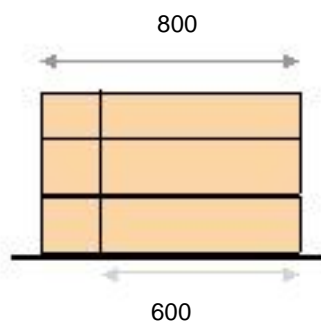
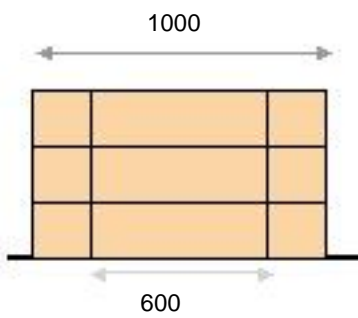

## ACESSÓRIOS



**Grelha inox apanha  
molhos 700 x420**



**GAVETA DE CINZA  
COM ESTRADO 680X420**



**cuba inox 380x380 (não inclui torneira )**

## **SOBRE MEDIDA**

**Executamos churrasqueiras VISION ARTE a sua medida**

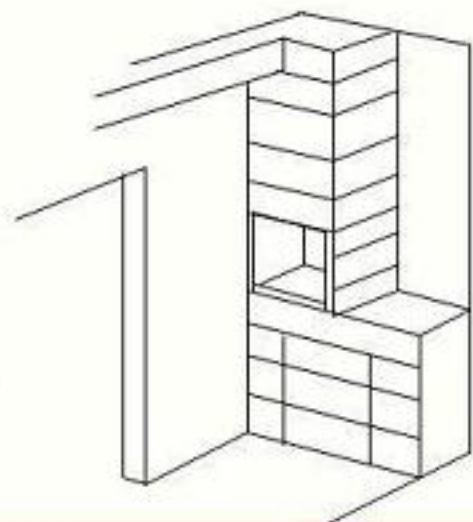
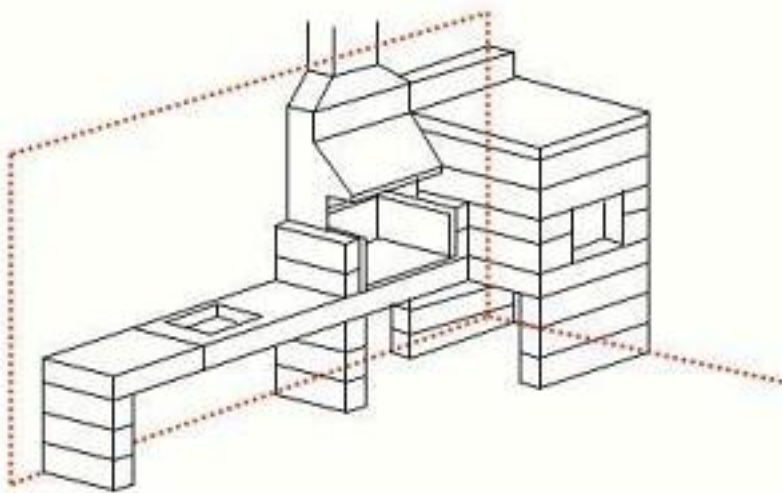

## **ALGUNS EXEMPLOS**

**TRIANA 230.10  
COM PROTEÇÃO PAREDE  
INOX**

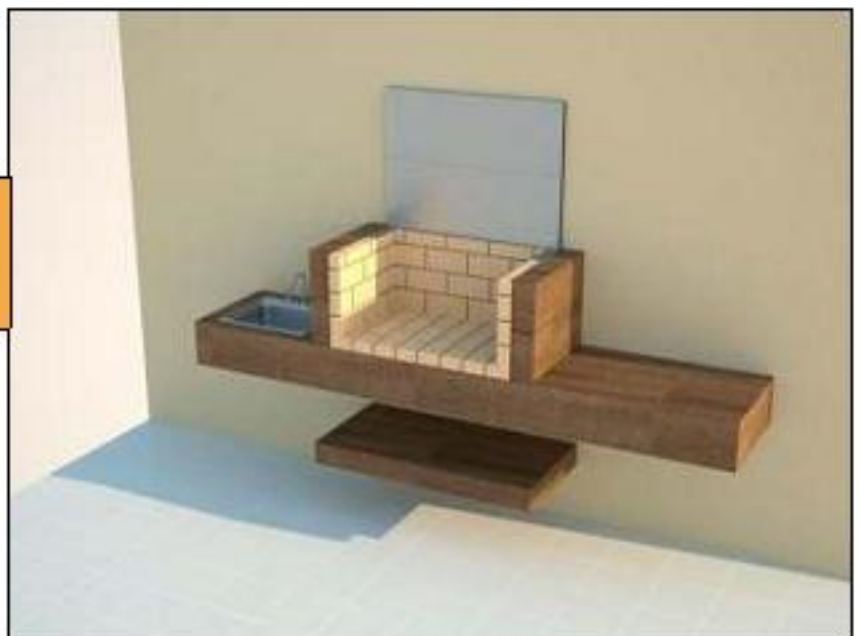



**TRIANA 150.10  
CAMPANULA POLKA**

**TRIANA 180.10  
CAMPANULA KUBICA**







**OCTAVIA**

**TRIANA CANTO 200  
CAMPANULA POLKA**



## FORMAÇÃO COMERCIAL

### INTRODUÇÃO.

A gama de churrasqueiras VISION ARTE foi criada para se enquadrar na nova arquitectura que nos últimos anos tem vindo a alterar o aspecto da nossa construção de moradias e edifícios .

A sua fácil aplicação , resistência e leveza são sem duvida as suas melhores características.

A sua aplicação é simplificada por ter um molde de marcação de furacão na parede, e as ferramentas necessárias são de bricolage ,acompanhadas com um folheto de montagem que simplifica totalmente a sua aplicação.

A zona de queima é feita totalmente em tijolo refractário. As estruturas metálicas de suporte e a sua ancoragem na parede, forem calculadas para suportar pesos acima daqueles que normalmente suportam .

A sua leveza , facilita o seu transporte e a sua aplicação. As churrasqueiras VISION ARTE tem um peso 5 vezes inferior as churrasqueiras convencionais de tijolo.

O acabamento (fenolico HPL exterior) são matérias que foram concebidos para estarem expostos as intempérie, resistem totalmente ao UV, e as temperaturas possíveis de atingir quando utilizadas para os diversos assados que possa fazer.

Resistência ao risco		EN 438-2-14
Resistência a água fervente 2hrs a 100°C		EN 438-2-7
Resistência à humidade		EN 438-2-27
Resistência à queimadura de cigarro		EN 438-2-18
Resistência a misturas salinas		ISO 4611
Resistência a fendilhar		EN 438-2-26
Resistência ao impacto		EN 438-2-12
Resistência à abrasão		EN 438-2-6
Contacto com alimentos		Não tóxico
Exposição à luz artificial		EN 438-2-16

1º-todas as churrasqueiras VISION ARTE podem ser feitas em 4 cores diferentes (4410 / 1993 / 4247 / 4411)

Para quantidades superior a 10 unidades iguais, temos outras cores disponíveis.

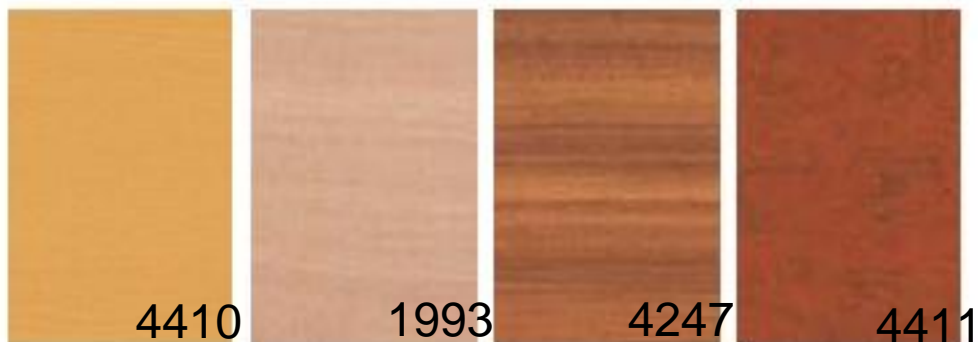

2º-todas as churrasqueiras tem que ter um muro de suporte (muro em betão ou tijolo alvenaria ) para serem aplicadas

3º-todas as churrasqueiras vem com todo o material necessário para efectuar a sua aplicação,(parafusos , Bucha química, mástiques de colagem, mástique refractário)

4º-os modelos das churrasqueiras são compostas com os seguinte nomes:

TTRIANA: são os modelos base

VIKTORIA: são os modelos Triana com moveis amovíveis por baixo

AGNES: modelo com bancada a 90ª de 80 cm

OCTAVIA: modelo Agnes com movel 100.

Duas opções de campanulas

1- campanula KUBICA

2- campanula POLKA

CANTO: são os modelos que preenchem um canto

5º-os números que estão a frente dos modelos tem o seguinte significado

O primeiro numero é o tamanho da estrutura de bancada ( Triana 100 .10 )

O segundo numero é o tamanho da prateleira ( Triana 100.10 )

As medidas das bancadas e das prateleiras são as seguintes ( 100/150/180/230)

150- zona de fogo mais uma bancada de 500 milímetros

180- zona de fogo mais uma bancada de 800 milímetros

230- zona de fogo mais uma bancada de 500 e 800 milímetros (nota a bancada de 500 tem que ficar do lado oposto a bancada de 800

A numeração é igual para os modelos Polka

6º-No caso Viktoria , as medidas são acompanhadas com moveis por baixo ou seja :

Viktoria 100 , é uma Triana 100 mais um móvel de 100

Viktoria 150 , é uma Triana 150 mais um móvel de 100 , mais um móvel de 50

80

50

100



## AÇESSORIOS

**7º-**Para os modelos Triana e Viktoria temos uma protecção de parede feita em duas peças de inox escovado de fácil aplicação e remoção.



**8º-**Para todos os modelos temos duas formas de prolongar a saída de fumos . Pode ser feita em tubo rectangular ou redondo existe uma peça redutora oculta para tubo rectangular de 250 x250 ou uma peça redutora oculta para tubo redondo de diâmetro 250.

**9º-** Nos tubos redondos e rectangulares temos troços de 1000, 500, 300, milímetros de comprimento.

Para tubo redondo temos um chapéu Saturno , para tubo rectangular o chapéu pequeno .

**10º-**Todos os acessórios de conduta são feitos em inox escovado



Nota importante: ao calcular o valor da conduta quer rectangular ou redonda , deduzir ao preço da churrasqueira o preço do chapéu grande (que esta incluído nos respectivos modelos com campânula ,o valor consta na tabela de preços .

**11º-**As cubas inox de 380 x380 podem ser postas nas bancadas de 500 e 800

Para mais informações [larfogo@larfogolareiras.com](mailto:larfogo@larfogolareiras.com)  
Direcção técnica – Luís Mesquita 966504325